



Contents lists available at ScienceDirect

Journal of Engineering Research

journal homepage: www.journals.elsevier.com/journal-of-engineering-research

Optimal energy management strategies for hybrid electric vehicles: A recent survey of machine learning approaches

Julakha Jahan Jui^a, Mohd Ashraf Ahmad^{a,*}, M.M. Imran Molla^b,
Muhammad Ikram Mohd Rashid^a

^a Faculty of Electrical and Electronics Engineering Technology (FTKEE), Universiti Malaysia Pahang (UMP), Pekan, Pahang, Malaysia

^b Department of Computer Science and Engineering, Pabna University of Science and Technology, Pabna, Bangladesh

ARTICLE INFO

Keywords:

Hybrid Electric Vehicles
Machine Learning
Energy Management Strategies

ABSTRACT

Hybrid Electric Vehicles (HEVs) have emerged as a viable option for reducing pollution and attaining fuel savings in addition to reducing emissions. The effectiveness of HEVs heavily relies on the energy management strategies (EMSs) employed, as it directly impacts vehicle fuel consumption. Developing suitable EMSs for HEVs poses a challenge, as the goal is to maximize fuel economy yet optimize vehicle performance. EMSs algorithms are critical in determining power distribution between the engine and motor in HEVs. Traditionally, EMSs for HEVs have been developed based on optimal control theory. However, in recent years, a rising number of people have been interested in utilizing machine-learning techniques to enhance EMSs performance. This article presents a current analysis of various EMSs proposed in the literature. It highlights the shift towards integrating machine learning and artificial intelligence (AI) breakthroughs in EMSs development. The study examines numerous case studies, and research works employing machine learning techniques across different categories to develop energy management strategies for HEVs. By leveraging advancements in machine learning and AI, researchers have explored innovative approaches to optimize HEVs' performance and fuel economy. Key conclusions from our investigation show that machine learning has made a substantial contribution to solving the complex problems associated with HEV energy management. We emphasize how machine learning algorithms may be adjusted to dynamic operating environments, how well they can identify intricate patterns in hybrid electric vehicle systems, and how well they can manage non-linear behaviors.

Introduction

In response to rising concerns about global warming and climate change, vehicle emission regulations are becoming increasingly stringent [1]. This has led to significant advancements in vehicle electrification and hybridization to comply with these regulations. One of the most impactful strategies to meet the rigorous emissions standards is the substitution of traditional vehicles powered by internal combustion with HEVs [2]. Hybrid electric vehicles (HEVs) combine an electric motor driven by a rechargeable battery and a traditional internal combustion engine to provide a cutting-edge method of transportation propulsion. Because of this hybridization, HEVs may smoothly transition between using an electric motor and a conventional engine, increasing fuel economy and lowering pollutants.

HEVs are characterized by their integration of diverse energy sources and power converters, typically the combination of an internal

combustion engine (ICE) and electric motor. HEVs are currently regarded as a cost-effectiveness and may provide a potential solution for the foreseeable future [3]. The primary objective in developing HEVs is to minimize fuel consumption and emissions while simultaneously addressing the power requirements of drivers. This is achieved by exploring suitable energy management strategies that can effectively allocate and utilize energy sources in HEVs.

Energy Management Strategies (EMSs) are crucial to attaining optimal power distribution in HEVs while minimizing fuel consumption and emissions in a variety of driving situations. The significance of EMSs in enhancing fuel economy and reducing emissions of HEVs is widely recognized [4]. The intricate nature of hybrid energy technologies, with numerous sources of energy and complex behaviors, presents challenges for the performance of EMSs. The main goal of EMSs, regardless of the powertrain arrangement, is to efficiently control and control the flow of electricity from energy converters to reach desired control goals [5].

* Corresponding author.

E-mail address: mashraf@ump.edu.my (M.A. Ahmad).

<https://doi.org/10.1016/j.jer.2024.01.016>

Received 23 July 2023; Received in revised form 13 January 2024; Accepted 17 January 2024

Available online 22 January 2024

2307-1877/© 2024 The Author(s). Published by Elsevier B.V. on behalf of Kuwait University. This is an open access article under the CC BY license (<http://creativecommons.org/licenses/by/4.0/>).

Therefore, the development of effective control strategies for specific driving cycles represents a prominent research focus in energy management strategies.

Numerous studies on Energy Management have led to the development of HEV Strategies based on rule-based methods, optimal Control theory, and reinforcement learning. Rule-based strategies have the advantage of being easily applicable to consumer vehicles because they only require a small amount of computation and utilize future information in a limited way when driving the control values [6,7]. However, the efficiency of the rule-based strategies is somewhat inferior to the results possibly obtained from true optimization. One of the most widely used theories in the study of HEV energy management is the optimal control theory. These strategies have the advantage of guaranteeing global optimum solutions but have the disadvantage of requiring heavy computations and relying on future-driving information to derive the optimal control values [8]. The optimal formulation of reinforcement learning is a Markov Decision Process (MDP), which consists of an environment and an agent. When applying a reinforcement learning framework to the HEV Energy Management problem, the environment corresponds to the HEV, and the agent corresponds to the strategy. Reinforcement learning-based strategies are more advantageous than generalisation strategies because actions are driven solely by observable states without the need for information about the future.

Most recently, the field of AI and ML has witnessed significant advancements, leading to their active integration in the development of control strategies for HEVs. Computers can now learn and carry out tasks based on training data rather than explicit programming, thanks to the scientific field of machine learning. Depending on how training data is organized and processed, machine learning approaches can be divided into three categories: supervised learning, reinforcement learning, and unsupervised learning. Reinforcement learning is the most difficult because it requires configuring both the environment and the agent, as well as defining the appropriate actions, states, and rewards for effective learning. Consequently, there has been a growing interest in utilizing machine learning techniques, particularly supervised and unsupervised learning, in the development of innovative EMSs for HEVs. In contrast to prior review publications [9,10,11], this one tries to give a thorough overview of newly developed EMSs based on contemporary research and machine learning. It also identifies critical upcoming trends in creating and improving EMSs for HEVs. The study's findings and conclusions are intended to be a valuable resource for researchers working in the area and to encourage the continued development of efficient EMSs for HEVs.

Hybrid electric vehicles (HEVs)

Emergence of hybrid electric vehicle

Modern civilization has benefited enormously from the invention of the vehicle, which has expanded mobility in daily life. Internal Combustion Engine (ICE) development has been crucial to the automobile industry. On the other hand, the release of hazardous compounds, including carbon dioxide (CO₂), carbon monoxide (CO), nitrogen oxides (NO_x), unburned hydrocarbons (HCs), and other pollutants has led to environmental issues such as pollution, global warming, and ozone layer depletion. The environment and the health of people are both seriously endangered by these pollutants. Additionally, a decrease in petroleum usage is necessary due to the limited nature of petroleum supplies. Alternative transportation solutions have arisen to solve these issues, using ICEs as the primary power source and batteries or electric motors as backup power sources. Due to this, electric vehicles (EVs), hybrid electric vehicles (HEVs), and plug-in hybrid electric vehicles have all been developed (PHEVs). Cleaner emissions, increased fuel efficiency, financial effectiveness, and environmental friendliness are just a few benefits that these cars may provide. They support environmentally friendly transportation options and lessen dependency on petroleum by incorporating electric power sources. HEVs are cars that use two or more

power sources to move forward, often an electric motor and an internal combustion engine (ICE). To optimize power distribution and boost fuel efficiency, HEVs employ a battery to store and discharge energy and a powertrain that can switch between the internal combustion engine and an electric motor.

Due to their use of high-efficiency electric motors and controls, as well as their capacity to be fueled by alternate energy sources, HEVs have grown in popularity. The first electric vehicle (EV) was created by Gustave Trouve in 1881. It was a tricycle with a 0.1 horsepower direct current motor that was driven by lead-acid batteries [12]. EVs offer effective, clean, and environmentally responsible urban transportation, but their limited range is a disadvantage. The creation of HEVs addressed the problems of higher battery prices, a lower driving range, and EV performance limitations [13]. By combining an ICE with an electric motor, HEVs maximize their advantages over both ICE and EV cars and subsequently reduce their drawbacks. In HEVs, the battery serves as an ICE's supported power supply during vehicle propulsion, reducing fuel use and harmful emissions. The Lohner-Porsche Mixte Hybrid, developed by Ferdinand Porsche in 1901, stands as the pioneering gasoline-electric hybrid vehicle [14]. Unlike EVs, HEVs do not require external charging, as the batteries are charged either by the engine or through regenerative braking. However, this limits their electric range and necessitates longer recharging times. PHEVs present a promising medium-term solution by allowing the batteries to be charged through the grid. In contrast to HEVs, PHEVs use larger motors and a larger onboard rechargeable battery to store energy and replace liquid fuels with less expensive grid electricity [15]. The larger battery in PHEVs has a higher energy capacity, which improves their fuel economy. Additionally, the ease of charging the battery from the main power supply at home, in parking lots, or in garages adds to the allure of PHEVs.

Structure of hybrid electric vehicle

There are several kinds of HEVs, and they are classified into series, parallel, and power-split architectures according to the powertrain structure, as shown in Fig. 1(a), 1(b), and 1(c), respectively. Each structure has its characteristics, advantages, and disadvantages.

The series hybrid powertrain is considered an addition to a battery-powered electric vehicle where the propulsion is solely provided by an electric motor. In this configuration, a generator is attached to the engine that produces electrical power. The power produced here can be mixed with energy stored in the system and sent to the electric motor or motors that drive the wheels through an electric bus. The simplicity of the series hybrid drivetrain is its primary benefit, as it only requires electrical connections between the key power conversion components. This simplifies vehicle packaging and design. Additionally, since the engine is decoupled from the wheels, it offers flexibility in selecting engine speed and load, allowing for operation in a high-efficiency region. However, the series hybrid powertrain does have some drawbacks. Efficiency losses are caused by the two energy conversions involved: the generator's conversion from mechanical to electrical and the motor's conversion from electrical to mechanical. Even in cases when there is a direct mechanical link between the engine and the wheels, these modifications have an impact on the total efficiency. As a result, a series hybrid electric car may occasionally use more gasoline than a conventional vehicle, especially while traveling on highways. Additionally, as it acts as the main source of propulsion, one of the electromechanical energy converters needs to be sized to handle the maximal power requirement of the vehicle [16]. The series hybrid powertrain topology is depicted in Fig. 1(a).

In the parallel hybrid powertrain topology, the engine is mechanically coupled to the powertrain while the motor propels the vehicle. Depending on load conditions, either the engine or the motor can power the vehicle, resulting in improved fuel economy. The motor is primarily responsible for power delivery at lower speeds, reducing fuel

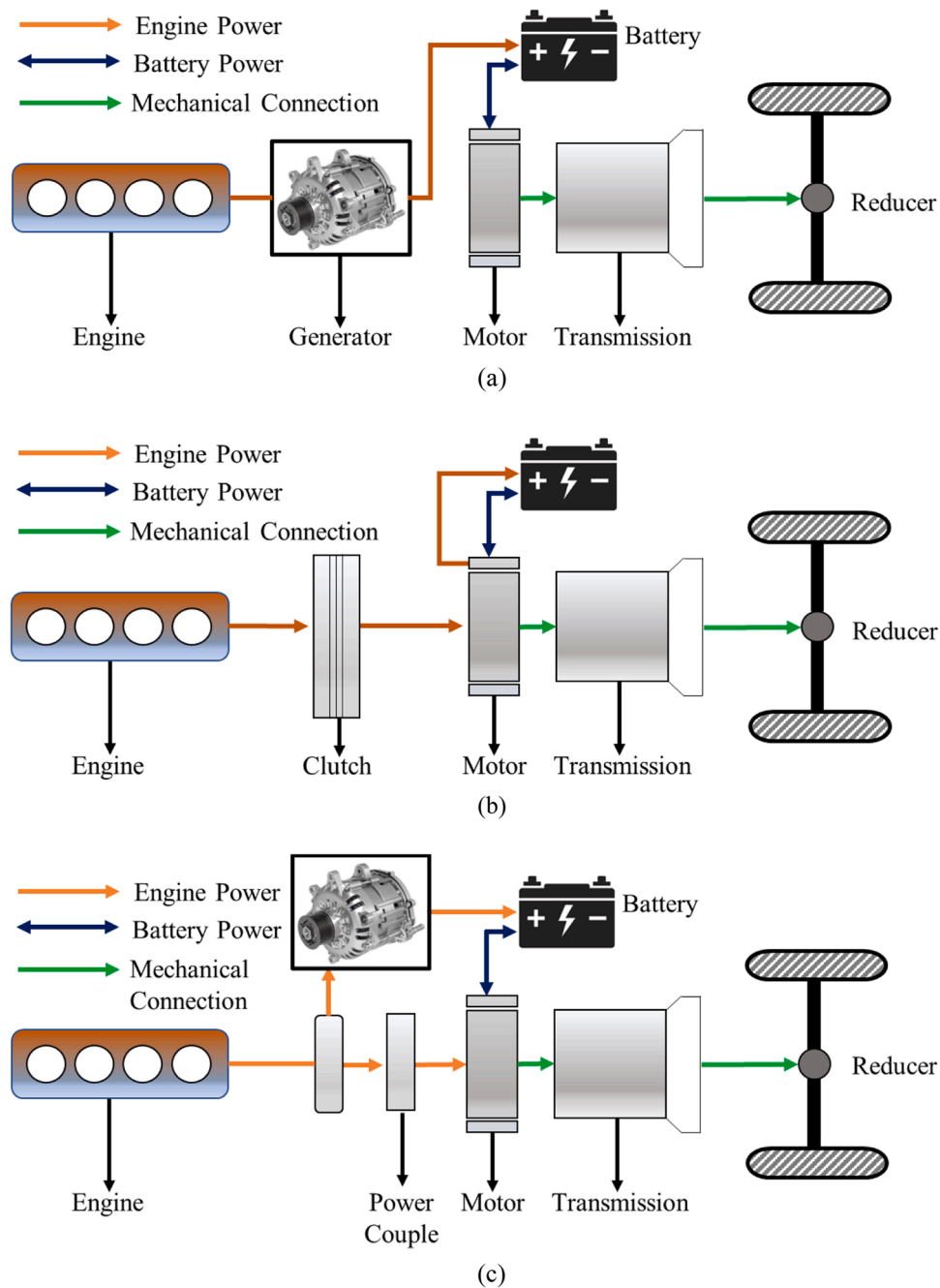

Fig. 1. Hybrid electric vehicle configurations. (a) series configuration, (b) parallel configuration, (c) power-split configuration.

consumption and maintaining higher efficiency. Unlike the series hybrid powertrain, the power summation in the parallel configuration is mechanical rather than electrical. The engine and electric motor(s) are connected using a gear set, chain, or belt, allowing their torques to be combined and transmitted to the wheels. Unlike with a series hybrid powertrain, one of the electromechanical energy converters in this system does not need to be sized to satisfy the maximum power requirement. However, the electric motors in a parallel hybrid powertrain typically have lower power ratings compared to those in a series hybrid powertrain, as not all the mechanical power flows through them. This can limit the potential for regenerative braking. Additionally, the operating conditions of the engine in a parallel hybrid powertrain are not as freely regulated as in a series hybrid powertrain. The vehicle's velocity via the transmission system is mechanically tied to the engine speed [16]. Fig. 1 shows the parallel hybrid powertrain topology (b).

The ability to operate in both series and parallel modes is one of the critical benefits of the power-split hybrid powertrain design. With more operating modes made possible by this adaptability, total efficiency may be significantly increased, especially in challenging driving situations. Decoupling the engine, generator, and motor rates, which increases control flexibility, is the primary advantage of the power-split design, even though the series operating path is typically avoided because it is inefficient. In this setup, a power split mechanism, a planetary gear set, is often used to connect the engine and two electric machines. This configuration enables both series and parallel operations by combining the power produced by the engine and the electric devices via electrical and mechanical routes. The power-split design provides maximum flexibility and control over the engine's operating circumstances compared to the parallel hybrid powertrain. It incorporates the benefits of both series and parallel operations while minimizing overall losses by

utilizing series operations only for a little percentage of the overall power need. This configuration involves the double energy conversion characteristic of a series operation, but only a fraction of the power flows through it, reducing losses [16]. The power-split hybrid powertrain topology is depicted in Fig. 1(c).

Classification of energy management strategies

The term "energy management strategies" (EMSs) describes a collection of organized plans, formulas, or techniques used to effectively regulate and maximize the use of energy resources within a specific system. EMSs include the dynamic allocation and distribution of energy from various sources, such as internal combustion engines and electric motors, to meet performance requirements while maximizing energy efficiency in the context of hybrid electric vehicles (HEVs) and other energy-intensive applications. Energy Management Systems for Hybrid Electric Vehicles can be classified into several categories based on their design principles and strategies. The classification of common energy management strategies is shown in Fig. 2.

Rule-Based EMSs rely on a predefined set of rules and logic to make energy management decisions. Typically founded on expert knowledge and heuristics, these recommendations define the actions to be taken in a variety of circumstances. The system could prioritize the electric motor when driving in urban areas at speed and transition to the internal combustion engine when traveling at higher speeds. Rule-Based EMSs offer simplicity and clarity, but they might not be flexible enough to handle different driving situations. The rules must be established and arranged in a rule base or set to execute a rule-based EMS. Depending on the design of the system, the rule base can be viewed as a group of rules that are assessed sequentially or concurrently. The rule-based EMSs choose the right rule(s) that best suit the present circumstances after continually evaluating the system status. The measures to be made to maximize energy management are then determined by the chosen rule(s). For rule-based EMSs to function, a set of rules must be created that codifies the knowledge and skill of engineers or domain experts. These regulations are often drawn from engineering concepts, vehicle specs, and system dynamics. Each rule describes a particular situation or condition, and the corresponding action specifies the control command or implementation technique. The operating parameters of the vehicle, such as the battery's state of charge, its speed, and its engine load, are continuously monitored by the rule-based EMSs while it is in operation. The predetermined rules are compared to the current state, and the action associated with the first rule that meets the requirements is carried out. In this hierarchical or priority-based process, rules with a higher priority typically take precedence over rules with a lower priority.

The energy management problem is formulated as an optimization job in optimization-based techniques. The best control actions that reduce fuel consumption or increase efficiency are found using

mathematical optimization approaches like dynamic programming or quadratic programming. EMSs that are based on optimization may handle more complicated driving situations and simultaneously optimize numerous goals. They may, however, have significant computing needs and call for a priori understanding of vehicle dynamics. The main idea behind optimization-based EMSs is to identify the best course of action for controlling the system to minimize fuel consumption, cut emissions, and increase overall system efficiency. The system dynamics, powertrain components, and driving circumstances are mathematically represented, and the energy management issue is formulated as an optimization job. The optimization process involves formulating constraints that consider elements like battery state of charge (SoC), power demand, component limitations, and vehicle dynamics, as well as defining an objective function that captures the optimization goal, such as minimizing fuel consumption or maximizing efficiency. These limits guarantee that the solution is practical and complies with the HEV system's operating constraints. Various optimization algorithms can be employed to solve the formulated optimization problem. These algorithms iteratively adjust the control variables, such as engine torque, motor torque, and battery power, to search for the optimal solution that satisfies the objective function and constraints. Commonly used optimization techniques include dynamic programming, quadratic programming, evolutionary algorithms, and model predictive control.

Learning-based approaches leverage machine learning algorithms to learn and adapt energy management strategy based on historical data and real-time feedback. With the use of a dataset of driving patterns and the accompanying best control actions, supervised or reinforcement learning algorithms are taught. The best energy management plan for fresh driving scenarios may then be predicted using the learned model. EMSs that are learning-based have the benefit of flexibility since they can continuously get better at what they do via experience. However, for training, they may require considerable training data and processing power. The fundamental idea behind learning-based EMSs is to use historical driving data and performance metrics to train a machine-learning model to capture the intricate connections between various inputs (such as battery charge, vehicle speed, and road conditions) and the corresponding optimal control actions (e.g., engine torque, motor torque, battery power). To train the model, input-output pairings from a big dataset are fed into it, and the model is then given time to discover underlying patterns and correlations. The trained model may be used in real-time applications after the learning phase to forecast the best power distribution and control moves based on the driving conditions at the moment. The vehicle's operational parameters are continually monitored by the learning-based EMSs, which also gather real-time sensor data and feed it into the trained model to provide the most effective control orders. This gives the EMSs the ability to adjust to various driving situations, road conditions, and driver behavior, improving energy economy and performance.

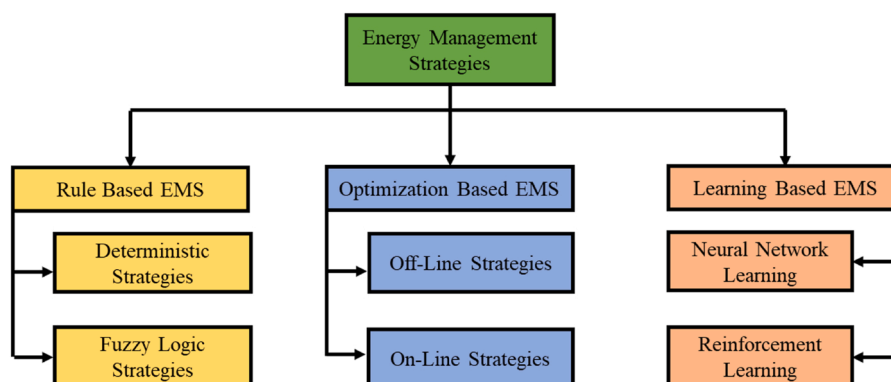

Fig. 2. Classification of common Energy Management Strategies.

Energy management strategies using ML algorithms

With the help of machine learning, decision-makers can execute an effective energy management strategy for hybrid electric vehicles by using a powerful tool that allows the agent to "learn" how to "act" in the best possible way [17]. This method allows the agent to observe the environment's condition and respond appropriately based on the data gathered, all while earning a reward for their efforts. In order to achieve this, the agent aims to "learn" from its prior experience in order to implement a certain policy that would ensure the reward. This policy is based on a mapping from every conceivable state to an action. Recently, there has been significant progress in utilizing machine learning techniques and artificial intelligence (AI) in developing control strategies for HEVs. With the use of training data, computers can now accomplish tasks without explicit programming due to the scientific field of machine learning. Depending on how the training data is organized, machine learning can be divided into three categories: supervised learning, reinforcement learning (including semi-supervised learning), and unsupervised learning (see Fig. 3). In this study, the power distribution strategies for HEVs based on machine learning are classified according to these categories.

In supervised learning, input data is expressed as a feature, and target data are paired to form the training data. Supervised learning can be used to perform classification or regression tasks. Standard supervised learning algorithms includes Random forests [18,19,20] Logistic regression [21], Support vector machines (SVM) [21], K-nearest neighbours (KNN) [22], artificial neural networks (ANN) [23]. A classification problem is one in which the dependent variable is expressed as categorical data, while a regression problem is one in which the dependent variable is expressed as continuous data. Supervise learning is the most widely used machine learning frameworks when developing power distribution Strategies for HEVs. To carry out supervised learning, it is necessary to derive target data corresponding to the features. Optimal control theory is generally used to derive these labeled data for supervised learning-based HEV strategies [24].

Reinforcement learning is also known as semi-supervised learning because the agent is trained to maximize the reward it receives through various experiences under conditions where the target data is not explicitly given. In recent years, the field of reinforcement learning has been rapidly developed through the fusion with deep learning, which is then called deep reinforcement learning (DRL). Taking advantage of the fact that deep learning can derive efficient feature representations for complex states or actions, DRL can effectively solve complex problems that cannot be solved using the existing reinforcement learning framework [25]. Since DRL derives power distribution Strategies for HEVs use

only observable states, many studies have taken advantage of DRL to develop energy management strategies that can ensure generalization performance [26].

Unsupervised learning consists of only input values without the target data. Representative algorithms for unsupervised learning include clustering and dimensionality reduction algorithms. Clustering refers to a machine learning technique that classifies data based on a similarity measure between features. Dimension reduction algorithms are algorithms that reduce the number of feature dimensions and lower the co-linearity between features. In [27], authors classified derived profiles using the k-means clustering algorithm and developed a power distribution strategy in which different co-state maps were applied according to how each driving profile was classified. The energy management strategy for HEVs using machine learning algorithms is depicted in Fig. 4. The development of a framework for machine learning algorithms in the energy management strategy for HEVs plays a crucial role in optimizing the performance and efficiency of these vehicles. This framework encompasses various phases and components that enable the effective utilization of machine learning techniques for energy management.

One of the primary phases in this framework is offline training. The mapping between input states and ideal action parameters is learned at this stage by utilizing historical data to train machine learning algorithms. Popular algorithms such as DRL or supervised learning (SL) are frequently used for this purpose. A great deal of computing power and time are required for the training process to produce accurate and reliable models. After the performance of the model has been validated, the trained model is then saved for future use.

Deploying the learned model into the actual HEV system is the next step in the framework. The integration of the model into the HEV's Vehicle Control Unit (VCU) or other pertinent components occurs often throughout this period. Using the proper software and programming languages, such as MATLAB/Simulink or C code, the model is converted into a controller. Real-time energy management choices must be made by this controller while taking into consideration the condition of the vehicle and its operational needs.

After the trained model has been deployed, the framework enables online learning and adaptability. During this phase, the model perpetually modifies its decision-making process in response to real-time data received from the HEV system. This allows the model to adapt to changing traffic conditions, user preferences, and external influences in real-world situations, ensuring optimal energy management. During the online learning phase, when the model interacts with the environment, receives feedback or incentives, and modifies its behavior as needed, reinforcement learning techniques may be implemented.

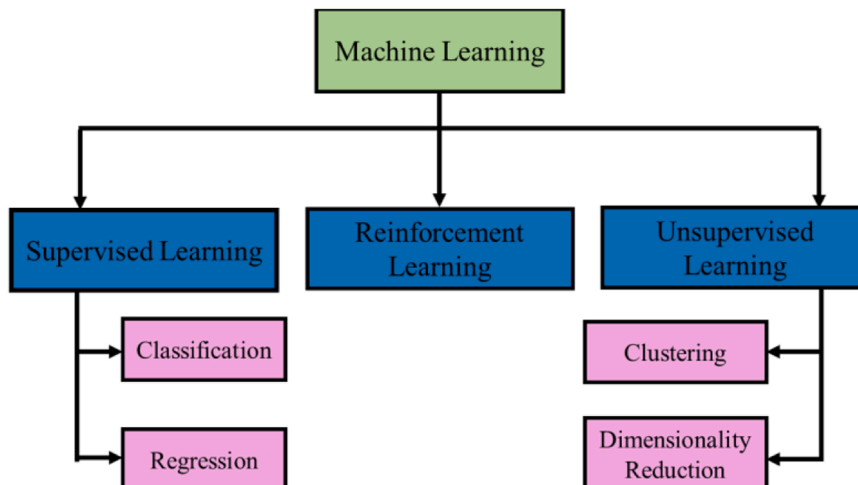

Fig. 3. Classification of Machine Learning.

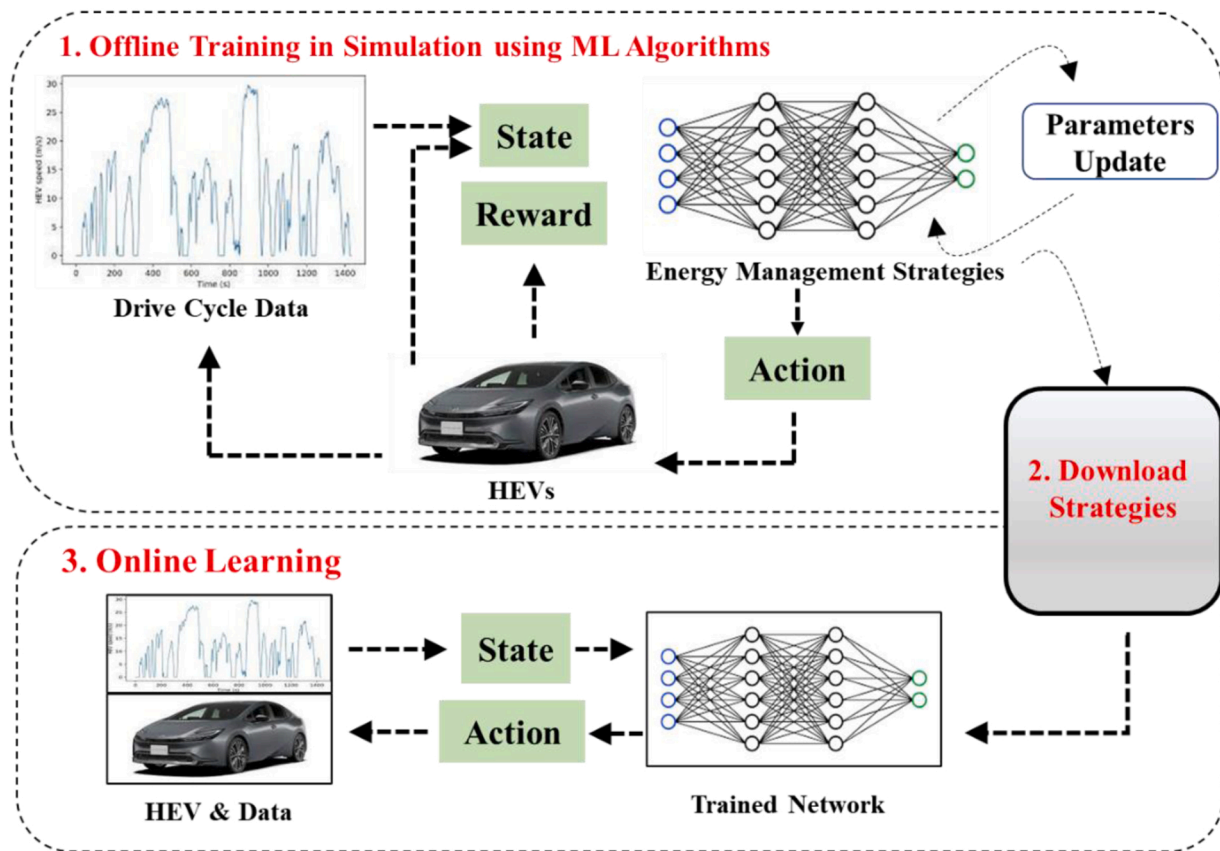

Fig. 4. Framework for Machine learning algorithm in the energy management strategy for hybrid electric vehicle [28].

EMS based on the supervised learning framework

The automobile industry has turned its attention to more environmentally friendly alternatives, such as HEVs, in response to the increased interest in decreasing greenhouse gas emissions. Nevertheless, HEVs require an efficient energy management system to maximize fuel economy and minimize emissions. Since supervised learning techniques enable the prediction of vehicle behavior and the optimization of power distribution, they have been applied to create efficient EMSs for HEVs. Fig. 5 depicts a typical framework for creating supervised learning based HEVs energy management techniques. To create training data for the supervised learning process, HEVs power distribution strategies are developed by generating target data that corresponds to a feature. Models like Artificial neural networks (ANN), support vector machines (SVM), Decision Tree (DT) and random forest (RM) model systems are then trained with this data. Thus, setting the goal values that correspond

to a feature is one of the most crucial aspects of supervised learning. Future driving information has been identified as the focus in numerous research, and energy management methods have been created based on this data [29,30]. The primary function of this statistical model is optimal control, which is dependent on predictions made by ML algorithms.

The support vector machine is one of the popular algorithm and it has been used in HEV energy management in several research [32,33, 34]. An SVM-based EMS was developed in one research by Zheng et al. [35] to estimate a vehicle’s upcoming driving cycles and correctly alter the power distribution between the engine and electric motor. The findings demonstrated that, in comparison to the rule-based technique, the SVM-based EMSs significantly increased fuel economy. Hou et al. [36] new energy management technique for PHEVs with increased flexibility was proven to have improved energy-saving performance under various driving circumstances. Liu et al. [37] presented a least

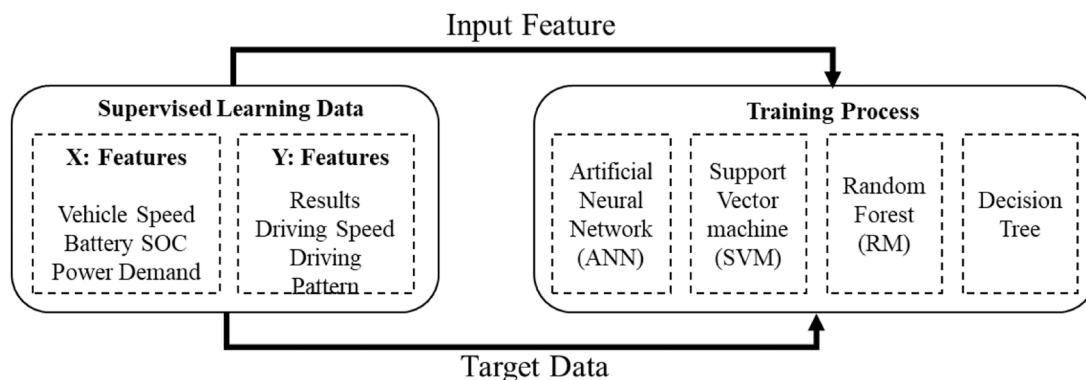

Fig. 5. Structure for the supervised learning algorithm in the hybrid electric vehicle’s energy management strategy [31].

square support vector machine (LSSVM) based controller for PHEVs, which exhibited the ability to quickly generate optimal policies in various driving scenarios. Their research showed that the data-driven controller effectively translated global optimization knowledge into real-time control strategies, resulting in superior control performance. A similar approach was proposed in [38] for driving cycle prediction within a connected vehicular-cloud environment. In [39], an event-based anomaly detection algorithm utilizing a one-class support vector machine (SVM) was developed for hybrid electric vehicles, showcasing its feasibility and effectiveness in detecting both known and unknown anomalies.

Another popular algorithm for HEV energy management is artificial neural networks (ANNs) [40]. Artificial Neural Networks (ANN) are effective in approximating nonlinear relationships between inputs and outputs by utilizing large datasets without relying on explicit mathematical formulas. Due to their robustness and error tolerance, ANN is a popular subfield of Machine Learning (ML) which is widely utilized in predictive modelling and optimal control of nonlinear systems [41,42]. In the context of EMSs, ANN is often applied in online EMSs where it possesses self-learning capabilities and offers optimal solutions [43]. Additionally, ANN excels at processing large volumes of data to yield accurate results [44]. Moreover, ANN is well-suited for handling multiobjective nonlinear problems, while Model Predictive Control (MPC) is particularly advantageous in situations with constraints.

In a study by Amit et al. [45], ANN-based EMSs were developed for a plug-in HEV, which predicted the optimal power distribution between the battery, engine, and electric motor. The results showed that the ANN-based EMSs achieved a 5% improvement in fuel economy compared to rule-based EMSs. An analogous technique was also employed in [46], where the authors applied ANN in a two-step procedure to operate the microgrid by displaying the mode of operation and charge-discharge of the energy storage system (ESS). In another study by [47], Artificial Neural Networks (ANN) were employed in a three-layer propulsion-mission analysis-EMSs integrated multiobjective optimization scheme for hybrid electric aircraft. The model demonstrated significant reductions in block fuel burn, achieving a reduction of - 44.62%, - 31.47%, and - 21.86% at flight range designs of 1000nmi, 1250nmi, and 1500nmi, respectively. Yavasoglu et al. [48] implemented an ML-based ANN optimization algorithm, resulting in a substantial increase of 51.85% in battery lifetime. Xin et al. [49] combined Dynamic Programming (DP) and ANN for the EMSs of a fuel cell vehicle. DP was utilized to achieve optimal control laws in the prediction horizon, while ANN served as the future velocity predictor, creating an energy management framework using model prediction control theory. According to Panaparambil [50], ANN is characterized by its adaptive and learning abilities [51], high parallelism, fault tolerance, memory, and its nonlinear global role. A comparison of SoC, Fuzzy Logic (FL), and ANN-based energy management strategies was conducted [52], revealing that ANN achieved minimal energy consumption and outperformed rule-based techniques in terms of optimality [53]. The performance of ANN heavily relies on the quality and processing of the collected data used for decision making.

In addition to SVM and ANN, other supervised learning algorithms have also been applied to HEV energy management. For example, Gan et al. [54] used a random forest (RF) algorithm to predict the power requirements of a hybrid energy ship based on an approximation model predictive control. Their model successfully reduced the amount of calculation and enabled the real-time operation of energy management in hybrid energy ships. In another study [55], an RF-based EMSs strategy was proposed. The findings showed that their suggested adaptive RF-based EMSs could significantly outperform conventional ones in terms of ultracapacitor consumption, battery protection, and system efficiency. Several studies have also utilized decision tree algorithms for energy management in HEVs. For example, Ramya et al. [56] proposed a Fuzzy-Based Energy Management System with a Decision Tree algorithm offers an approach to energy management that considers different

driving cycles and operating conditions. Furthermore, fuzzy logic-based EMSs were developed by Hatim et al. [57] for a parallel HEV. The fuzzy logic system predicted the optimal power distribution among the engine and electric motor based on the driving conditions, such as speed and acceleration. The results showed that the fuzzy logic-based EMSs achieved an improvement of 3.4% in fuel efficiency compared to rule-based EMSs. Other supervised learning algorithms that have been applied to HEV energy management include decision trees, k-nearest neighbor, and gradient boosting. For instance, a model predictive control (MPC) based on EMSs coupled with double Q-learning (DQL) was developed by Chen et al. [58] to transfer the power among several power sources for PHEVs. The predictive model mainly carries out optimum control based on prediction results derived from two machine learning algorithms. Xiang et al. derived a probability distribution and a transfer matrix through a Markov decision process to predict vehicle velocity [59]. In this study, the power distribution strategy was developed by formulating an MPC algorithm that derives control values from the predictive speed through the transfer matrix and dynamic programming results for the prediction horizon. Nan et al. constructed various model-based velocity predictors and compared the performance of each velocity predictor through the result of the MPC algorithm [60]. Murphey et al. constructed an energy management system that determines battery power and engine rotational speed through a hierarchical neural network structure [61]. Xie et al. used a neural network system to predict the equivalent factor that equalized the fuel consumption and battery SoC change in the Equivalent Cost minimization strategy (ECMS) algorithm [62]. Zhuang et al. developed an SVM model that can predict the optimal operating mode by deriving the operating mode corresponding to vehicle speed and torque demands using Dynamic Programming (DP) simulation results [63].

Table 1 presents significant papers on supervised learning algorithms used for energy management strategies in HEVs. The studies can be divided into categories based on characteristics, goals, and techniques applied to classification and regression issue series. It should be noted that the EMSs for HEVs use both regression and classification

Table 1
Summary of EMSs Based on Supervised Machine Learning Techniques.

Ref.	Algorithms	Features	Targets	Problem types
[56]	Decision Tree	Vehicle speed, acceleration, and battery state of charge	Fuel consumption and emissions	Regression
[45]	Artificial Neural Network	Battery state of charge, vehicle speed, and road slope	Fuel economy and battery life	Regression
[48]	Artificial Neural Network	Engine speed, throttle position, and fuel injection timing	Engine faults	Classification
[37]	Least Square Support Vector Machine	Engine speed, throttle position, and air-fuel ratio	Vehicle emissions	Classification
[54]	Random Forest	Engine speed, throttle position, and vehicle speed	Fuel consumption	Regression
[64]	Gradient Boosting	Vehicle speed, battery state of charge, and road grade	Fuel economy	Regression
[55]	Random Forest	Road slope, vehicle speed, and battery state of charge	Energy efficiency	Classification
[38]	Support Vector Machine	Battery state of charge, vehicle speed, and road grade	Battery degradation	Regression

techniques; the classification model is used to predict driving styles, operating modes, and gear ratio, and the regression algorithm is used to forecast speed, engine torque, and battery power.

EMSs based on the reinforcement learning framework

For HEVs to reduce fuel use and emissions while preserving vehicle performance, energy management is essential. The development of ideal EMSs for HEVs has shown considerable promise for reinforcement learning (RL) algorithms [65,66,67]. We concentrate on EMSs built on RL frameworks in this part and discuss current advancements in the area. A particular kind of machine learning algorithm called RL uses interactions with the environment to learn through making mistakes. It has become more well-known in recent years as a result of its capacity to create optimum control strategies without requiring a priori understanding of the dynamics of the system. RL-based EMSs for HEVs have been proposed by several researchers, and they have demonstrated promising results in terms of fuel efficiency and emissions reduction. Since 2014, several RL technique types, such as Q-learning, temporal-difference (TD) learning, and Dyna-style, were progressively implemented in the EMSs industry. Of all the RL algorithms, Q-learning is the one that is used the most frequently. DRL algorithms can be further divided into Deep Q-network (DQN), double DQN (DDQN), deterministic policy gradient (DPG), and deep deterministic policy gradient (DDPG) algorithms that used in the current research on DRL-based EMSs for HEVs.

RL algorithms handle optimal decision-making issues by self-learning without prior knowledge, and three important components are involved: the agent, the environment, and the reward [61]. The purpose of RL algorithms is to maximise the accumulated scalar reward by interacting with the environment continuously. Through a constant trial and error-search process, the agent eventually learns an ideal control approach [61]. Furthermore, the Markov property is a distinguishing feature of RL algorithms, in which modifications in future states of the system are only related to the present system states. In that instance, the RL algorithm's decision process is known as the Markov decision process (MDP). The MDP is represented as a tuple $\{A, B, T, W\}$, where A and B indicate the state space and action space, respectively, $T: A \times B \times A \rightarrow [0, 1]$ indicates the transition probability across all states, and $W: A \times B \rightarrow \mathbb{R}$ denotes the reward. The basic goal of RL is to learn an optimal strategy that mappings state A to optimum action B , with maximum accumulate reward $W = \sum_{i=0}^N \beta^i \cdot x(i)$, where $\beta \in [1]$ represents the discount factor.

The Q-value is used in RL algorithms to analyse and measure the sum of long-term rewards under the executive action, i.e., a higher Q-value indicates that the associated action is more likely to be implemented. Q-value updates are based on the Bellman equation, which is depicted below [68]:

$$Q'(a_i, b_i) = Q(a_i, b_i) + \alpha \cdot [x(a_i, b_i) + \beta \cdot \max M(a_{i+1}, b_{i+1}) - M(a_i, b_i)] \quad (1)$$

Where α is the learning rate; $Q'(a_i, b_i)$ is the Q-value to be updated at the next time-step; $Q(a_i, b_i)$ denotes the calculated Q-value under the current state a_i and action b_i ; $x(a_i, b_i)$ denotes the current reward under the current state a_i and action b_i ; $M(a_{i+1}, b_{i+1})$ denotes the estimated Q-value for the next state a_{i+1} and next action b_{i+1} .

The essential agent-environment interaction of the RL algorithm for HEVs is depicted in Fig. 6. At each time step, the agent selects an action b_i at arbitrary based on the current state a_i , and the environment provides the associated scalar reward x_i to the agent based on a_i and b_i . The state then changes to a_{i+1} at the following time step. This process will continue until the training is completed. When the RL approach is put to the HEVs area, the conditions of driving and the specific vehicle model can be the environment; the states, like battery state of charge (SOC), vehicle velocity, vehicle power demand, and torque demand, can be the vehicle status; the actions, like battery output power, ICE torque, or motor torque, can be the power split-related variables.

For HEVs, an RL-based EMSs is typically used to determine the best controlling approach among batteries and ICes. Chen et al. [69] proposed an RL-based EMS for a plug-in hybrid electric bus; this was one of the earliest studies in this discipline. Real-time traffic data and battery deterioration were taken into account for determining the best battery SoC trajectory for the bus. An RL-based EMS for a series-parallel HEV was proposed in a different work by Tang et al. [70]. The best power distribution between the engine and the electric motor was determined using the RL algorithm while taking into account a variety of driving scenarios and vehicle characteristics. When compared to a traditional rule-based EMS, it was demonstrated that the suggested EMSs might enhance fuel efficiency by as much as 8.7%. Additionally, EMSs for HEVs with numerous energy storage devices have been optimized using RL. An RL-based EMSs for a plug-in hybrid electric bus with a hybrid energy storage system (HESS) made up of a lithium-ion battery and a supercapacitor, for instance, was proposed by Bassey et al. [71]. The ideal power distribution between the HESS components was established using the RL algorithm, which also considered the battery's age and current traffic conditions. An imitation reinforcement learning-based method with optimum guidance was developed for energy regulation in hybrid cars in the study conducted by Liu et al. [72]. The objective of the algorithm was to solve problems faster while maintaining adequate control performance. The results demonstrated that the proposed strategy effectively reduced the energy consumption of HEVs under a variety of driving conditions. The research also implied that the method could offer effective solution assistance for analogous constraints-based information-required mechanical and electrical system issues. Overall, the results demonstrated how the imitation reinforcement learning-based method may be used to optimize energy control for HEVs.

Q-learning has been used in the context of EMSs to solve issues related to uncertainty and unpredictability in driving cycles. This strategy has the benefit of minimizing calculation time while

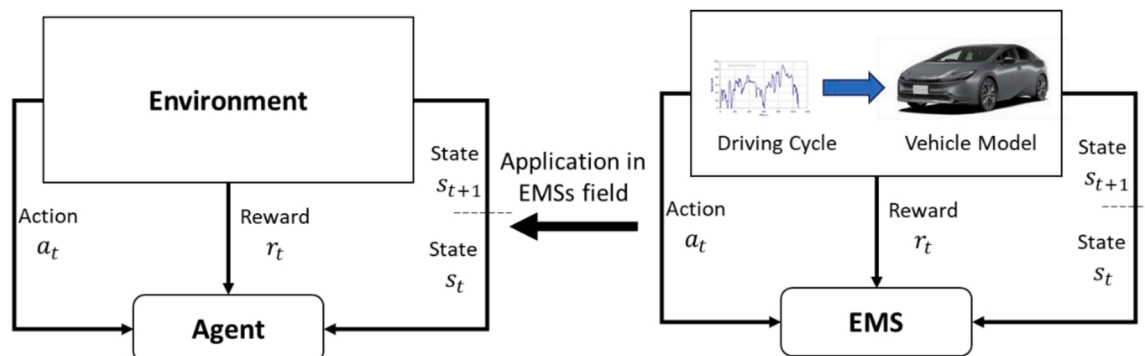

Fig. 6. The idea behind RL algorithms and how they are used in HEVs [68].

significantly increasing fuel efficiency. An evaluation of the impacts of Q-learning, ECMS, and continuous temperature management techniques on HEV fuel efficiency was researched by Xu et al. [73] in comparative research. The results showed that Q-learning was more effective than other methods in improving fuel efficiency. In contrast to conventional Q-learning techniques, Shuai et al.'s [74] model-free supervisory control systems for automobiles showed better energy efficiency while driving but maintaining optimal battery charge. Zhou et al. [75] published an inventive multi-step Q-learning approach that permits online optimisation of EMSs throughout their entire life cycle. This algorithm allows the system to adapt and optimise its operation using real-time data, thereby enhancing overall performance and efficiency that allows for online optimization of EMSs over their full life cycle. The system can adapt and optimize its operation using real-time data owing to this algorithm, which improves overall performance and efficiency. To balance fuel consumption and battery life, research by Ahmadian et al. [76] provides a Q-learning-based controlling technique for the management of energy in series-parallel based hybrid automobiles. According to the findings, fuel consumption was reduced by 1.25% and 0.68% for the HWFET and IM240 cycles, respectively, while battery life increased by 65% and 50%. The study also demonstrated gains in battery life of 47% and 36% for UDDS and NEDC cycles, respectively. A real-time self-adaptive Q-learning controller for energy management in conventional autonomous cars was suggested in another study by Fayyazi et al. [77]. In comparison to conventional Q-learning methods, the suggested self-adaptive Q-learning algorithm showed a 23% improvement in operating time. These results demonstrated how Q-learning may be used to optimize energy management tactics for various hybrid and autonomous vehicle types.

The combination of Q-learning and deep learning in the form of deep Q networks (DQN) has garnered prominence in the field of DRL and has been used to improve the efficacy of RL-based EMSs for HEVs. Zhang et al. [78] introduced DRL-based EMSs for a series-parallel HEV, leveraging a deep neural network to approximate the optimal power split system. Their proposed EMSs achieved a fuel economy improvement of up to 11.7% compared to conventional rule-based EMSs. Wang et al. [79] utilized an enhanced parameterized DQN algorithm, which reduced driving costs by 3.1% and extended battery life effectively. Guodong Du et al. [80] proposed DRL-based EMSs for series hybrid electric vehicles (SHEVs), demonstrating faster training speed, higher fuel economy, and convergence towards the global optimum compared to existing DRL methods. In [81], a hierarchical structure and deep Q-learning algorithm (DQL-H) were employed to obtain an optimal energy management solution, outperforming other reinforcement learning-based approaches in terms of training efficiency and fuel consumption. Moreover, a recent study focused on a longevity-conscious energy management strategy using reinforcement learning [82]. The training results demonstrated that accounting for fuel cell system degradation resulted in a 0.53% decrease in the EMSs' fuel economy, reaching 88.7%. However, the proposed strategy effectively prevented the fuel cell system from degrading. Moreover, the proposed strategy exhibited a significant improvement in computational efficiency of over 70% compared to a dynamic programming-based strategy.

In a separate study by Zheng et al. [83], a Multi objective RL algorithm was utilized to develop an EMSs for a plug-in HEV by achieving a 20% reduction in fuel consumption compared to rule-based EMSs while balancing battery degradation and driver comfort. Zhang et al. [84] proposed a double deep Q-network (DDQN)-guided EMSs for an electric-hydraulic hybrid electric vehicle, combining Q-learning with deep neural networks. Liu et al. [85] introduced a Q-learning-based adaptive energy management strategy for a hybrid electric tracked vehicle, demonstrating strong adaptability, optimality, and learning ability with reduced computational time. Xiong et al. [86] applied the same algorithm to obtain optimal power distribution in a plug-in HEV, resulting in a significant energy loss reduction of 16.8%. However, the discrete states of Q-learning limit its applicability in HEV energy

management. Another study proposed a deep reinforcement learning-based energy management strategy called the DDPG algorithm for a range-extended fuel cell hybrid electric vehicle [87]. A DDQL algorithm was implemented for instantaneous power allocation optimization based on planned velocity [88]. The simulation results demonstrated that integrating traffic signals, powertrain parameters, and speed forecast of prior vehicles in PHEV velocity management improved fuel economy, driving comfort, and traffic efficiency by achieving smoother vehicle velocity.

Deep Deterministic Policy Gradients (DDPG), an advanced RL algorithm, have been utilized in EMSs applications for HEVs [89]. DDPG, a combination of Deterministic Policy Gradient (DPG) and Deep Q-Network (DQN), is a potent model-free off-policy RL algorithm. By employing experience replay and a frozen target network, DQN enhances the learning of the Q-function. DDPG extends the original DQN from a discrete space to a continuous space, allowing for learning a deterministic policy within the actor-critic framework. In a study by Wu et al. [90], a DDPG algorithm was used to develop EMSs for a parallel HEV. The DDPG algorithm was trained on a simulation platform, and the results showed that the proposed EMSs could achieve a 16.3% reduction in fuel use compared to rule-based EMSs. In that study, a more effective technique was given by taking into account the number of passengers and traffic data in addition to vehicle information. To enhance the economic performance of a hybrid electric tracked carrier and lessen the computing burden, Ma et al. [91] used DDPG with a time-varying weighting factor. The findings showed that the DDPG-based EMSs, when equipped with an online updating mechanism, were able to achieve almost 90% of the fuel economy attained by DP while drastically cutting down on calculation time. A hardware-in-loop experiment further demonstrated that the suggested technique may be implemented in real-time applications. A unique EMS based on Double Deep Reinforcement Learning was created by Tang et al. [74] developed an innovative EMS based on Double Deep Reinforcement Learning. DQN was used to master the gear-shifting technique, while DDPG was used for engine throttle control. The suggested DDRL-based EMSs demonstrated a 2.33% improvement in fuel economy compared to the Deterministic Dynamic Programming (DDP)-based EMSs through offline training and subsequent online simulation testing, thereby resolving certain intrinsic DDP approach shortcomings. An improved energy management framework was presented by Lian et al. [92] and included DDPG regulations. By integrating existing knowledge of battery characteristics and statistics on brake-specific fuel consumption (BSFC), the suggested technique enabled speedier learning and improved fuel economy. A list of EMSs for HEVs based on reinforcement machine learning approaches is shown in Table 2.

These methods optimize the power allocation, power distribution, and control actions in HEVs using algorithms like DRL, DQN, DDPG, Q-learning, and DDQL. The algorithms work with many different states, such as SoC, velocity, distance traveled, battery SoC and fuel consumption, vehicle speed, acceleration, wheel speed, and wheel power. The algorithms decide how much power to distribute, disperse it evenly, and manage engine torque, motor torque, engine rational speed, and motor power. These EMSs techniques' primary objective is to increase the HEVs' overall performance in terms of energy management and fuel economy. Faster training rates, greater fuel economy, enhanced fuel efficiency, less energy consumption, and longer battery life are all benefits of the activities.

EMSs based on the unsupervised learning framework

To maximize the efficiency and performance of HEVs, EMSs are essential. The capacity of the unsupervised learning framework to find patterns and associations in data without the requirement for explicit supervision is making it increasingly popular in the development of EMSs for HEVs. In this overview of the literature, we focus on clustering- and optimization-based methods for applying unsupervised learning

Table 2
Summary of EMSs Based on reinforcement Machine Learning Techniques.

Ref	Algorithms	States	Actions	Rewards
[80]	Deep reinforcement learning (DRL)	SoC, velocity	Power allocation	Faster training speed and higher fuel economy
[69]	Deep Q-Network (DQN)	Vehicle speed, SoC	Power allocation	Fuel efficiency
[70]	Proximal Policy Optimization (PPO)	SOC, distance traveled	Power distribution	Energy consumption
[92]	Deep deterministic policy gradient (DDPG)	Battery SoC and fuel consumption	N/A	Fuel efficiency
[71]	Deterministic Policy Gradient (DPG)	SoC, velocity	Power allocation	Energy efficiency
[76]	Q-learning Algorithm	N/A	N/A	fuel consumption and battery life
[90]	DDPG	Vehicle Speed, acceleration, battery SoC	Engine torque, motor torque, engine rational speed	Cost for fuel, cost for electric energy
[88]	Double delayed Q-learning (DDQL)	SoC, velocity	Power allocation	Energy efficiency
[78]	DRL	Battery SoC, wheel speed, wheel power	Motor power	Fuel consumption, electric energy
[81]	Q-learning algorithm	Battery SoC, vehicle Speed	Engine torque	Fuel consumption, battery SoC,

techniques for EMSs in HEVs. Fig. 7 depicts a typical framework for creating unsupervised learning based HEVs energy management techniques. Unsupervised learning algorithms operate by identifying similarities in the data and performing clustering based on only X (features) and not on Y (labels) [93]. Three primary objectives are carried out using unsupervised learning models: dimensionality reduction, association, and clustering.

Clustering-based techniques utilize clustering algorithms to combine similar driving behaviors and modify energy management as required. The KMeans clustering technique is one of the most simple yet effective unsupervised learning algorithms. For instance, Lin et al. [94] suggested clustering-based EMSs that used a genetic algorithm to optimize the EMSs and a Gaussian mixture model to cluster the driving patterns. Similarly, Wang et al. [95] suggested a dynamic clustering-based EMS that would be optimized using both a fuzzy clustering method and a reinforcement learning algorithm. Through the use of the k-means clustering technique, Choi et al. [96] identified driving patterns and created an equivalent factor map for the EMSs for a driving pattern. Liu et al. [97] used principal component analysis (PCA) to reduce feature space and classify features of driving conditions. In [98], real-time blended EMSs for PHEVs were presented, which incorporated driving conditions identified by the K-means clustering algorithm using Global Positioning System (GPS) and Geographical Information System (GIS). Similarly, in [99], a hierarchical clustering algorithm was proposed to simplify the optimal solution dataset. Both strategies demonstrated significant energy consumption savings of over 95%, without relying on

prior driving conditions and with reduced computational intensity, thus showcasing their feasibility for online application.

Optimization-based approaches in EMSs focus on directly optimizing the EMSs without the need for clustering techniques. Wang et al. [100] presented fuzzy optimization-based EMSs that employed a fuzzy rule-based system and a genetic algorithm for optimization. Their strategy optimization solution combined fuzzy logic control (FLC) with driving cycle recognition, culminating in relatively close fuel efficiency and steady battery charge sustainability. In another study by Yang et al. [101], optimization-based EMSs using a particle swarm optimization algorithm were proposed. This approach achieved a minimum fuel consumption reduction of 10% and 4.5%, respectively. In the proposed EMSs, a reduction in battery capacity loss ranging from 6.42% to 9.72% was observed, albeit with a slight increase in fuel consumption. Similar optimization-based approaches were explored in [102] to optimize EMSs with a focus on minimizing operating costs associated with energy purchase and energy storage system operation. In [103], an enhanced GA-SVM model for predicting vehicle speed was established, and its effectiveness was validated through test results. A fuzzy control energy management technique optimized by evolutionary algorithms was given by the authors in [104] for hybrid energy storage systems in electric vehicles. Huiying Liu et al. [105] developed multiobjective predictive EMSs using the nondominated sorting genetic algorithm (NSGA-II) to enhance the durability of PEMFCs and batteries while reducing economic costs. For power distribution in FCHEVs, Tao et al. [106] developed a fuzzy energy management technique based on enhanced Q-learning and GA by eliminating the need for prior knowledge of the driving mode. Yuan et al. [107] proposed an optimized rule-based energy management strategy for hybrid power systems, utilizing a genetic algorithm to optimize power allocation among the fuel cell and batteries. This approach enabled optimal power allocation while reducing computational burden by leveraging expert experience and global optimization properties.

Hybrid approaches that combine clustering-based and optimization-based methods have shown improved performance in EMSs. For example, Feng et al. [108] introduced hybrid EMSs that utilized a self-organizing map for clustering driving patterns and a differential evolution algorithm for optimizing the EMSs. Their method achieved significant reductions in peak battery charging current and peak discharging current. Peak charging and discharging currents were lowered by 42.94% and 27.73%, respectively, while peak charging and discharging currents were reduced by 62.19% and 56.97%. Other hybrid EMSs were proposed by Tayab et al. [109], which employed a salp swarm algorithm and a hybrid forecasting approach for optimizing the EMSs. The primary goals of their research were to reduce the overall running costs of a grid-connected microgrid (MG) and to estimate PV power and load demand in the short term. Abolfazl et al. [110] employed the fractional-order Darwinian particle swarm optimization (FODPSO) method in fuzzy methodology to optimize the performance of a three-phase induction motor.

Table 3 presents a summary of EMSs based on unsupervised machine-learning techniques for HEVs. These techniques utilize algorithms such as Gaussian Mixture Model + GA, Fuzzy Clustering Algorithm + RL, Fuzzy Rule-Based System + GA, Self-Organizing Map + Differential Evolution, Clustering Algorithm + Salp Swarm Algorithm, and K-Means Clustering + PSO to optimize energy management in HEVs. These algorithms operate on various features, including driving

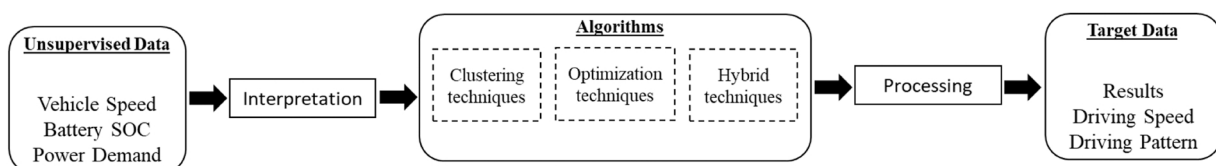

Fig. 7. The idea behind unsupervised learning algorithms and how they are used in HEVs [93].

Table 3
EMSS Based on Unsupervised Machine Learning Techniques.

Ref.	Algorithms	Features	Targets
[94]	Gaussian Mixture Model + GA	Driving patterns, SoC	Energy efficiency
[95]	Fuzzy Clustering Algorithm + RL	Battery voltage, SoC	Optimal energy management
[100]	Fuzzy Rule-Based System + GA	Traffic conditions	Battery charging schedule
[108]	Self-Organizing Map + DEA	Driving conditions	Energy management optimization
[109]	Clustering Algorithm + Salp Swarm Algorithm	Driving patterns	Energy management optimization
[102]	K-Means Clustering + PSO	Vehicle speed, SoC	Power allocation
[106]	Q-learning and GA	N/A	Power allocation

patterns, SoC, battery voltage, traffic conditions, driving conditions, vehicle speed, and SoC. The targets of these EMSs strategies vary and include energy efficiency, optimal energy management, battery charging schedule, and energy management optimization.

Challenges and future directions

Challenges

Developing the best energy management strategies for HEVs has been made possible by machine learning algorithms, but there are still several issues that need to be resolved.

- i. *Data availability*: To learn from the environment and improve the power flow, machine learning algorithms need considerable training data. However, because of privacy issues, poor data quality, and the high cost of data acquisition, gathering and interpreting real-world data from HEVs can be difficult.
- ii. *Model complexity*: Complex models created by machine learning algorithms may be challenging to understand and test. This can make it difficult to find faults, correct them, or enhance the model's performance.
- iii. *Computing resources*: Machine learning-based energy management solutions for HEVs need to be developed and implemented. However, this may not be possible or cost-effective for all users.

Future directions

Despite these challenges, there are several exciting directions for future research:

- i. *Development of new algorithms*: New machine learning techniques are required to handle the issues of data availability, model complexity, and processing resources while enhancing the efficiency of energy management systems for HEVs.
- ii. *Hybrid models*: To increase performance and resilience, hybrid models that blend machine learning algorithms with traditional tactics can make use of each approach's capabilities.
- iii. *Integration with vehicle-to-grid (V2G) systems*: HEV and V2G system integration may open up new possibilities for energy management and optimization. Intelligent V2G systems that balance the grid's energy demand and supply while guaranteeing HEV performance may be created using machine learning techniques.
- iv. *Real-world validation*: To assure their effectiveness and dependability, machine learning-based energy management solutions for HEVs should be tested in real-world situations. Collaboration between researchers, automakers, and other stakeholders will be necessary to achieve this.

Conclusion

This study offers a comprehensive assessment of the most recent advances in machine learning-based optimized EMSs for HEVs. The analysis of energy management systems has revealed that good power flow regulation is essential to obtaining these advantages. The overview of HEVs emphasizes their fuel economy and emissions reduction advantages. The review of optimal EMSs focuses on the most recent advancements in this field, and the section on machine learning methods examines their suitability for developing energy management plans for HEVs. Overall, the survey reveals that it is a smart strategy to use machine learning algorithms to design optimal energy management strategies for HEVs. Using the massive amounts of data that HEVs supply, these algorithms may learn from and improve the power flow, resulting in greater fuel economy and fewer pollutants. Nevertheless, there are still problems with data accessibility, model complexity, and the accessibility of computing resources. To solve these issues, future research should focus on developing new algorithms and hybrid models and integrating them with vehicle-to-grid systems. In order to assure the effectiveness and dependability of machine learning-based energy management solutions for HEVs, real-world validation is also required. The application of machine learning algorithms to HEV energy management is an intriguing and rapidly developing area with the potential to improve transportation sustainability significantly. Continued research and collaboration between academia, industry, and other stakeholders will be necessary to overcome the challenges and fully realize the benefits of this technology.

Declaration of Competing Interest

The authors declare the following financial interests/personal relationships which may be considered as potential competing interests. Julakha Jahan Jui reports financial support was provided by Malaysian Ministry of Higher Education.

Acknowledgment

We thank the Malaysian Ministry of Higher Education for funding our research (grant No. FRGS/1/2022/TK07/UMP/03/8) (university ref. no. RDU220107), as well as University Malaysia Pahang for their support in providing facilities to complete this paper.

References

- [1] A. Panday and H. O. Bansal, A Review of Optimal Energy Management Strategies for Hybrid Electric Vehicle, *International Journal of Vehicular Technology*, vol. 2014, pp. 1–19, Nov. 2014, doi: 10.1155/2014/160510.
- [2] W. Enang, C. Bannister, Modelling and control of hybrid electric vehicles (A comprehensive review), *Renew. Sustain. Energy Rev.* vol. 74 (2017) 1210–1239, <https://doi.org/10.1016/j.rser.2017.01.075>.
- [3] F.R. Salmasi, Control strategies for hybrid electric vehicles: evolution, classification, comparison, and future trends, *IEEE Trans. Veh. Technol.* vol. 56 (5) (2007) 2393–2404, <https://doi.org/10.1109/TVT.2007.899933>.
- [4] F. Zhang, X. Hu, R. Langari, D. Cao, Energy management strategies of connected HEVs and PHEVs: recent progress and outlook, *Prog. Energy Combust. Sci.* vol. 73 (2019) 235–256, <https://doi.org/10.1016/j.pecs.2019.04.002>.
- [5] K. Deng, et al., Deep reinforcement learning based energy management strategy of fuel cell hybrid railway vehicles considering fuel cell aging, *Energy Convers. Manag.* vol. 251 (2022) 115030, <https://doi.org/10.1016/j.enconman.2021.115030>.
- [6] M.F. M. Sabri, K.A. Danapalasingam, M.F. Rahmat, A review on hybrid electric vehicles architecture and energy management strategies, *Renew. Sustain. Energy Rev.* vol. 53 (2016) 1433–1442, <https://doi.org/10.1016/j.rser.2015.09.036>.
- [7] C. Xiang, F. Ding, W. Wang, W. He, Energy management of a dual-mode power-split hybrid electric vehicle based on velocity prediction and nonlinear model predictive control, *Appl. Energy* vol. 189 (2017) 640–653, <https://doi.org/10.1016/j.apenergy.2016.12.056>.
- [8] L. Tang, G. Rizzoni, S. Onori, Energy Management Strategy for HEVs Including Battery Life Optimization, *IEEE Transactions on Transportation Electrification*, vol. 1, no. 3, pp. 211–222, Oct. 2015, doi: 10.1109/TTE.2015.2471180.

- [9] S. Shahriar, A.R. Al-Ali, A.H. Osman, S. Dhou, M. Nijim, Machine learning approaches for EV charging behavior: a review, *IEEE Access* vol. 8 (2020) 168980–168993, <https://doi.org/10.1109/ACCESS.2020.3023388>.
- [10] Q. Feiyan and L. Weimin, A Review of Machine Learning on Energy Management Strategy for Hybrid Electric Vehicles, in *2021 6th Asia Conference on Power and Electrical Engineering (ACPEE)*, IEEE, Apr. 2021, pp. 315–319. doi: 10.1109/ACPEE51499.2021.9437082.
- [11] J.S. Vardakas, I. Zengin, C. Verikoukis, *Machine Learning Methodologies for Electric-Vehicle Energy Management Strategies, in Connected and Autonomous Vehicles in Smart Cities*, First edition. | Boca Raton, FL: CRC Press/Taylor & Francis Group, LLC, 2021.: CRC Press, 2020, pp. 115–132. doi: 10.1201/9780429329401-4.
- [12] L. Tian, X. Liu, Study on control strategy for composite power supply system of EV, *J. Phys. Conf. Ser.* vol. 1748 (5) (2021) 052054, <https://doi.org/10.1088/1742-6596/1748/5/052054>.
- [13] F. Un-Noor, S. Padmanaban, L. Mihet-Popa, M. Mollah, E. Hossain, A comprehensive study of key electric vehicle (EV) components, technologies, challenges, impacts, and future direction of development, *Energies* vol. 10 (8) (2017) 1217, <https://doi.org/10.3390/en10081217>.
- [14] A. Panday and H.O. Bansal, A Review of Optimal Energy Management Strategies for Hybrid Electric Vehicle,” *International Journal of Vehicular Technology*, vol. 2014, pp. 1–19, Nov. 2014, doi: 10.1155/2014/160510.
- [15] S. Chu, A. Majumdar, Opportunities and challenges for a sustainable energy future, *Nature* vol. 488 (7411) (2012) 294–303, <https://doi.org/10.1038/nature11475>.
- [16] F. Zhang, L. Wang, S. Coskun, H. Pang, Y. Cui, J. Xi, Energy management strategies for hybrid electric vehicles: Review, classification, comparison, and outlook, *Energies (Basel)*, vol. 13, no. 13, pp. 1–35, 2020, doi: 10.3390/en13133352.
- [17] Ethem Alpaydin, Introduction to machine learning, in *Advanced Topics in Artificial Intelligence*, 1992, pp. 104–138. doi: 10.1007/3-540-55681-8_33.
- [18] A.S.M. Shafi, M.M.I. Molla, J.J. Jui, M.M. Rahman, Detection of colon cancer based on microarray dataset using machine learning as a feature selection and classification techniques, *SN Appl. Sci.* vol. 2 (7) (2020) 1–8, <https://doi.org/10.1007/s42452-020-3051-2>.
- [19] M.M. Imran Molla, J.J. Jui, B.S. Bari, M. Rashid, M.J. Hasan, Cardiotocogram data classification using random forest based machine learning algorithm,” *Lecture Notes in Electrical Engineering*, vol. 666, no. January, pp. 357–369, 2021, doi: 10.1007/978-981-15-5281-6_25.
- [20] J.J. Jui, M.M. Imran Molla, B.S. Bari, M. Rashid, M.J. Hasan, Flat Price Prediction Using Linear and Random Forest Regression Based on Machine Learning Techniques,” *Lecture Notes in Electrical Engineering*, vol. 678, no. January, pp. 205–217, 2020, doi: 10.1007/978-981-15-6025-5_19.
- [21] M.M.I. Molla, J.J. Jui, H.K. Rana, N.K. Podder, Machine Learning Algorithms for the Prediction of Prostate Cancer, 2023, pp. 471–482. doi: 10.1007/978-981-19-7528-8_37.
- [22] M.M.I. Molla, Md.S. Islam, A.S.M. Shafi, M.K. Alam, Md.T. Islam, J.J. Jui, Feature Selection and Prediction of Heart Disease Using Machine Learning Approaches, 2022, pp. 951–963. doi: 10.1007/978-981-16-8690-0_83.
- [23] A. Kurani, P. Doshi, A. Vakharia, M. Shah, A comprehensive comparative study of artificial neural network (ANN) and support vector machines (SVM) on stock forecasting, *Ann. Data Sci.* vol. 10 (1) (2023) 183–208, <https://doi.org/10.1007/s40745-021-00344-x>.
- [24] Y. Zhang, et al., Machine learning-based vehicle model construction and validation—toward optimal control strategy development for plug-in hybrid electric vehicles, *IEEE Trans. Transp. Electr.* vol. 8 (2) (2022) 1590–1603, <https://doi.org/10.1109/TTE.2021.3111966>.
- [25] A. Mekrache, A. Bradai, E. Moulay, S. Dawaliby, Deep reinforcement learning techniques for vehicular networks: recent advances and future trends towards 6G, *Veh. Commun.* vol. 33 (2022) 100398, <https://doi.org/10.1016/j.vehcom.2021.100398>.
- [26] A. Mekrache, A. Bradai, E. Moulay, S. Dawaliby, Deep reinforcement learning techniques for vehicular networks: recent advances and future trends towards 6G, *Veh. Commun.* vol. 33 (2022) 100398, <https://doi.org/10.1016/j.vehcom.2021.100398>.
- [27] X. Sun, Y. Cao, Z. Jin, X. Tian, M. Xue, An adaptive ECMS based on traffic information for plug-in hybrid electric buses, *IEEE Trans. Ind. Electron.* vol. 70 (no9) (2023) 9248–9259, <https://doi.org/10.1109/TIE.2022.3210549>.
- [28] Y. Wang, H. Tan, Y. Wu, J. Peng, Hybrid electric vehicle energy management with computer vision and deep reinforcement learning, *IEEE Trans. Ind. Inf.* vol. 17 (no6) (2021) 3857–3868, <https://doi.org/10.1109/TII.2020.3015748>.
- [29] K. Liu, Z. Asher, X. Gong, M. Huang, I. Kolmanovsky, Vehicle Velocity Prediction and Energy Management Strategy Part I: Deterministic and Stochastic Vehicle Velocity Prediction Using Machine Learning, Apr. 2019. doi: 10.4271/2019-01-1051.
- [30] T.D. Gaikwad, Z.D. Asher, K. Liu, M. Huang, and I. Kolmanovsky, Vehicle Velocity Prediction and Energy Management Strategy Part 2: Integration of Machine Learning Vehicle Velocity Prediction with Optimal Energy Management to Improve Fuel Economy,” Apr. 2019. doi: 10.4271/2019-01-1212.
- [31] C. Song, et al., A review of optimal energy management strategies using machine learning techniques for hybrid electric vehicles, *Int. J. Automot. Technol.* vol. 22 (5) (2021) 1437–1452, <https://doi.org/10.1007/s12239-021-0125-0>.
- [32] Y. Zheng, F. He, X. Shen, X. Jiang, Energy control strategy of fuel cell hybrid electric vehicle based on working conditions identification by least square support vector machine, *Energies* vol. 13 (2) (2020) 426, <https://doi.org/10.3390/en13020426>.
- [33] P.K. Agyeman, et al., Parameter matching, optimization, and classification of hybrid electric emergency rescue vehicles based on support vector machines, *Energies* vol. 15 (19) (2022) 7071, <https://doi.org/10.3390/en15197071>.
- [34] A. Manoharan, K.M. Begam, V.R. Aparow, D. Sooriarmoorthy, Artificial neural networks, gradient boosting and support vector machines for electric vehicle battery state estimation: a review, *J. Energy Storage* vol. 55 (2022) 105384, <https://doi.org/10.1016/j.est.2022.105384>.
- [35] Y. Zheng, F. He, X. Shen, X. Jiang, Energy control strategy of fuel cell hybrid electric vehicle based on working conditions identification by least square support vector machine, *Energies* vol. 13 (2) (2020) 426, <https://doi.org/10.3390/en13020426>.
- [36] Z. Hou, J. Guo, J. Xing, C. Guo, Y. Zhang, Machine learning and whale optimization algorithm based design of energy management strategy for plug-in hybrid electric vehicle, *IET Intell. Transp. Syst.* vol. 15 (8) (2021) 1076–1091, <https://doi.org/10.1049/itr2.12084>.
- [37] Y. Liu, Y. Zhang, H. Yu, Z. Nie, Y. Liu, Z. Chen, A novel data-driven controller for plug-in hybrid electric vehicles with improved adaptabilities to driving environment, *J. Clean. Prod.* vol. 334 (2022) 130250, <https://doi.org/10.1016/j.jclepro.2021.130250>.
- [38] Y. Wang, K. Li, X. Zeng, B. Gao, J. Hong, Energy consumption characteristics based driving conditions construction and prediction for hybrid electric buses energy management, *Energy* vol. 245 (2022) 123189, <https://doi.org/10.1016/j.energy.2022.123189>.
- [39] Y. Ji, H. Lee, Event-based anomaly detection using a one-class SVM for a hybrid electric vehicle, *IEEE Trans. Veh. Technol.* vol. 71 (6) (2022) 6032–6043, <https://doi.org/10.1109/TVT.2022.3165526>.
- [40] R.S. Sankarkumar, R. Natarajan, Energy management techniques and topologies suitable for hybrid energy storage system powered electric vehicles: an overview, *Int. Trans. Electr. Energy Syst.* vol. 31 (4) (2021), <https://doi.org/10.1002/2050-7038.12819>.
- [41] C. Maino, D. Misul, A. Di Mauro, E. Spessa, A deep neural network based model for the prediction of hybrid electric vehicles carbon dioxide emissions, *Energy AI* vol. 5 (2021) 100073, <https://doi.org/10.1016/j.egyai.2021.100073>.
- [42] Q. Zhou, C. Du, A quantitative analysis of model predictive control as energy management strategy for hybrid electric vehicles: a review, *Energy Rep.* vol. 7 (2021) 6733–6755, <https://doi.org/10.1016/j.egyri.2021.09.119>.
- [43] Y. Luo, Y. Wu, B. Li, J. Qu, S. Feng, P.K. Chu, Optimization and cutting-edge design of fuel-cell hybrid electric vehicles, *Int. J. Energy Res.* vol. 45 (13) (2021) 18392–18423, <https://doi.org/10.1002/er.7094>.
- [44] C. Liu, Y. Wang, L. Wang, Z. Chen, Load-adaptive real-time energy management strategy for battery/ultracapacitor hybrid energy storage system using dynamic programming optimization, *J. Power Sources* vol. 438 (2019) 227024, <https://doi.org/10.1016/j.jpowsour.2019.227024>.
- [45] A.K. Rajput, J.S. Lather, Energy management of a DC microgrid with hybrid energy storage system using PI and ANN based hybrid controller, *Int. J. Ambient Energy* vol. 44 (1) (2023) 703–718, <https://doi.org/10.1080/01430750.2022.2142285>.
- [46] T.-G. Kim, H. Lee, C.-G. An, J. Yi, C.-Y. Won, Hybrid AC/DC microgrid energy management strategy based on two-step ANN, *Energies* vol. 16 (4) (2023) 1787, <https://doi.org/10.3390/en16041787>.
- [47] J. Zhang, I. Roumeliotis, A. Zolotas, Model-based fully coupled propulsion-aerodynamics optimization for hybrid electric aircraft energy management strategy, *Energy* vol. 245 (2022) 123239, <https://doi.org/10.1016/j.energy.2022.123239>.
- [48] H.A. Yavasoglu, Y.E. Tetik, H.G. Ozcan, Neural network-based energy management of multi-source (battery/UC/FC) powered electric vehicle, *Int. J. Energy Res.* vol. 44 (15) (2020) 12416–12429, <https://doi.org/10.1002/er.5429>.
- [49] W. Xin, W. Zheng, J. Qin, S. Wei, C. Ji, Energy Management of Fuel Cell Vehicles Based on Model Prediction Control Using Radial Basis Functions,” *J. Sens.* vol. 2021, pp. 1–8, May 2021, doi: 10.1155/2021/9985063.
- [50] V. Sidharthan Panaparambil, Y. Kashyap, R. Vijay Castelino, A review on hybrid source energy management strategies for electric vehicle, *Int. J. Energy Res.* vol. 45 (14) (2021) 19819–19850, <https://doi.org/10.1002/er.7107>.
- [51] R.S. Sankarkumar, R. Natarajan, Energy management techniques and topologies suitable for hybrid energy storage system powered electric vehicles: an overview, *Int. Trans. Electr. Energy Syst.* vol. 31 (4) (2021), <https://doi.org/10.1002/2050-7038.12819>.
- [52] S. Kalyankar-Narwade, R.K. Chidambaram, S. Patil, Neural network- and fuzzy control-based energy optimization for the switching in parallel hybrid two-wheeler, *World Electr. Veh. J.* vol. 12 (1) (2021) 35, <https://doi.org/10.3390/wevj12010035>.
- [53] J. Zhu, L. Chen, X. Wang, L. Yu, Bi-level optimal sizing and energy management of hybrid electric propulsion systems, *Appl. Energy* vol. 260 (2020) 114134, <https://doi.org/10.1016/j.apenergy.2019.114134>.
- [54] M. Gan, H. Hou, X. Wu, B. Liu, Y. Yang, C. Xie, Machine learning algorithm selection for real-time energy management of hybrid energy ship, *Energy Rep.* vol. 8 (2022) 1096–1102, <https://doi.org/10.1016/j.egyri.2022.02.200>.
- [55] M. Li, L. Wang, Y. Wang, Z. Chen, Sizing Optimization and Energy Management Strategy for Hybrid Energy Storage System Using Multiobjective Optimization and Random Forests, *IEEE Trans Power Electron.* vol. 36, no. 10, pp. 11421–11430, Oct. 2021, doi: 10.1109/TPEL.2021.3070393.
- [56] K. Ramya, Y. Teekaraman, K.A. Ramesh Kumar, Fuzzy-based energy management system with decision tree algorithm for power security system, *Int. J. Comput. Intell. Syst.* vol. 12 (2) (2019) 1173, <https://doi.org/10.2991/ijcis.d.191016.001>.
- [57] H. Jbari, R. Askour, B.B. Idrissi, Fuzzy logic-based energy management strategy on dual-source hybridization for a pure electric vehicle, *International Journal of*

- Electrical and Computer Engineering (IJECE), vol. 12, no. 5, p. 4903, Oct. 2022, doi: 10.11591/ijece.v12i5.pp4903-4914.
- [58] Z. Chen, H. Gu, S. Shen, J. Shen, Energy management strategy for power-split plug-in hybrid electric vehicle based on MPC and double Q-learning, *Energy* vol. 245 (2022) 123182, <https://doi.org/10.1016/j.energy.2022.123182>.
- [59] X. Tian, Y. Cai, X. Sun, Z. Zhu, Y. Xu, A novel energy management strategy for plug-in hybrid electric buses based on model predictive control and estimation of distribution algorithm, *IEEE/ASME Trans. Mechatron.* vol. 27 (6) (2022) 4350–4361, <https://doi.org/10.1109/TMECH.2022.3156150>.
- [60] N. Zhao, F. Zhang, Y. Yang, S. Coskun, X. Lin, X. Hu, Dynamic traffic prediction-based energy management of connected plug-in hybrid electric vehicles with long short-term-state of charge planning, *IEEE Trans. Veh. Technol.* (2023) 1–15, <https://doi.org/10.1109/TVT.2022.3229700>.
- [61] J. Hu, D. Liu, C. Du, F. Yan, C. Lv, Intelligent energy management strategy of hybrid energy storage system for electric vehicle based on driving pattern recognition, *Energy* vol. 198 (2020) 117298, <https://doi.org/10.1016/j.energy.2020.117298>.
- [62] S. Xie, X. Hu, Z. Xin, J. Brighton, Pontryagin's Minimum Principle based model predictive control of energy management for a plug-in hybrid electric bus, *Appl. Energy* vol. 236 (2019) 893–905, <https://doi.org/10.1016/j.apenergy.2018.12.032>.
- [63] W. Zhuang, X. Zhang, D. Li, L. Wang, G. Yin, Mode shift map design and integrated energy management control of a multi-mode hybrid electric vehicle, *Appl. Energy* vol. 204 (2017) 476–488, <https://doi.org/10.1016/j.apenergy.2017.07.059>.
- [64] Z. Chen, H. Gu, S. Shen, J. Shen, Energy management strategy for power-split plug-in hybrid electric vehicle based on MPC and double Q-learning, *Energy* vol. 245 (2022) 123182, <https://doi.org/10.1016/j.energy.2022.123182>.
- [65] S.E. Li, Deep Reinforcement Learning, in *Reinforcement Learning for Sequential Decision and Optimal Control*, Springer Nature Singapore, Singapore, 2023, pp. 365–402, https://doi.org/10.1007/978-981-19-7784-8_10.
- [66] T. Tiong, I. Saad, K.T.K. Teo, H. bin Lago, Deep Reinforcement Learning with Robust Deep Deterministic Policy Gradient, in *2020 2nd International Conference on Electrical, Control and Instrumentation Engineering (ICECIE)*, IEEE, Nov. 2020, pp. 1–5. doi: 10.1109/ICECIE50279.2020.9309539.
- [67] J. Clifton, E. Lader, Q-learning: theory and applications, *Annu Rev. Stat. Appl. vol. 7* (1) (2020) 279–301, <https://doi.org/10.1146/annurev-statistics-031219-041220>.
- [68] D. Xu, C. Zheng, Y. Cui, S. Fu, N. Kim, S.W. Cha, Recent progress in learning algorithms applied in energy management of hybrid vehicles: a comprehensive review, *Int. J. Precis. Eng. Manuf. Green. Technol.* vol. 10 (1) (2023) 245–267, <https://doi.org/10.1007/s40684-022-00476-2>.
- [69] Z. Chen, H. Hu, Y. Wu, Y. Zhang, G. Li, Y. Liu, Stochastic model predictive control for energy management of power-split plug-in hybrid electric vehicles based on reinforcement learning, *Energy* vol. 211 (2020) 118931, <https://doi.org/10.1016/j.energy.2020.118931>.
- [70] X. Tang, J. Chen, T. Liu, Y. Qin, D. Cao, Distributed deep reinforcement learning-based energy and emission management strategy for hybrid electric vehicles, *IEEE Trans. Veh. Technol.* vol. 70 (10) (2021) 9922–9934, <https://doi.org/10.1109/TVT.2021.3107734>.
- [71] B.E. Nyong-Basse, et al., Reinforcement learning based adaptive power pinch analysis for energy management of stand-alone hybrid energy storage systems considering uncertainty, *Energy* vol. 193 (2020) 116622, <https://doi.org/10.1016/j.energy.2019.116622>.
- [72] Y. Liu, Y. Wu, X. Wang, L. Li, Y. Zhang, Z. Chen, Energy management for hybrid electric vehicles based on imitation reinforcement learning, *Energy* vol. 263 (2023) 125890, <https://doi.org/10.1016/j.energy.2022.125890>.
- [73] B. Xu, F. Malmir, D. Rathod, and Z. Filipi, "Real-Time Reinforcement Learning Optimized Energy Management for a 48V Mild Hybrid Electric Vehicle," *Apr. 2019*. doi: 10.4271/2019-01-1208.
- [74] B. Shuai, et al., Heuristic action execution for energy efficient charge-sustaining control of connected hybrid vehicles with model-free double Q-learning, *Appl. Energy* vol. 267 (2020) 114900, <https://doi.org/10.1016/j.apenergy.2020.114900>.
- [75] Q. Zhou, et al., Multi-step reinforcement learning for model-free predictive energy management of an electrified off-highway vehicle, *Appl. Energy* vol. 255 (2019) 113755, <https://doi.org/10.1016/j.apenergy.2019.113755>.
- [76] S. Ahmadian, M. Tahmasbi, R. Abedi, Q-learning based control for energy management of series-parallel hybrid vehicles with balanced fuel consumption and battery life, *Energy AI* vol. 11 (2023) 100217, <https://doi.org/10.1016/j.egyai.2022.100217>.
- [77] M. Fayyazi, et al., Real-time self-adaptive Q-learning controller for energy management of conventional autonomous vehicles, *Expert Syst. Appl.* vol. 222 (2023) 119770, <https://doi.org/10.1016/j.eswa.2023.119770>.
- [78] C. Zhang, W. Cui, and N. Cui, "Deep Reinforcement Learning based Multi-Objective Energy Management Strategy for a Plug-in Hybrid Electric Bus Considering Driving Style Recognition," in *2022 6th CAA International Conference on Vehicular Control and Intelligence (CVCI)*, IEEE, Oct. 2022, pp. 1–6. doi: 10.1109/CVCI56766.2022.9965049.
- [79] H. Wang, H. He, Y. Bai, H. Yue, Parameterized deep Q-network based energy management with balanced energy economy and battery life for hybrid electric vehicles, *Appl. Energy* vol. 320 (2022) 119270, <https://doi.org/10.1016/j.apenergy.2022.119270>.
- [80] G. Du, Y. Zou, X. Zhang, L. Guo, N. Guo, Heuristic energy management strategy of hybrid electric vehicle based on deep reinforcement learning with accelerated gradient optimization, *IEEE Trans. Transp. Electrific.* vol. 7 (4) (2021) 2194–2208, <https://doi.org/10.1109/TTE.2021.3088853>.
- [81] C. Qi, et al., Hierarchical reinforcement learning based energy management strategy for hybrid electric vehicle, *Energy* vol. 238 (2022) 121703, <https://doi.org/10.1016/j.energy.2021.121703>.
- [82] X. Tang, H. Zhou, F. Wang, W. Wang, X. Lin, Longevity-conscious energy management strategy of fuel cell hybrid electric vehicle based on deep reinforcement learning, *Energy* vol. 238 (2022) 121593, <https://doi.org/10.1016/j.energy.2021.121593>.
- [83] C. Zheng, D. Zhang, Y. Xiao, W. Li, Reinforcement learning-based energy management strategies of fuel cell hybrid vehicles with multi-objective control, *J. Power Sources* vol. 543 (2022) 231841, <https://doi.org/10.1016/j.jpowsour.2022.231841>.
- [84] Z. Zhang, T. Zhang, J. Hong, H. Zhang, J. Yang, Q. Jia, Double deep Q-network guided energy management strategy of a novel electric-hydraulic hybrid electric vehicle, *Energy* vol. 269 (2023) 126858, <https://doi.org/10.1016/j.energy.2023.126858>.
- [85] T. Liu, W. Tan, X. Tang, J. Chen, D. Cao, Adaptive Energy Management for Real Driving Conditions via Transfer Reinforcement Learning, 2020.
- [86] R. Xiong, Y. Duan, J. Cao, Q. Yu, Battery and ultracapacitor in-the-loop approach to validate a real-time power management method for an all-climate electric vehicle, *Appl. Energy* vol. 217 (2018) 153–165, <https://doi.org/10.1016/j.apenergy.2018.02.128>.
- [87] Y. Huang, H. Hu, J. Tan, C. Lu, D. Xuan, Deep reinforcement learning based energy management strategy for range extend fuel cell hybrid electric vehicle, *Energy Convers. Manag.* vol. 277 (2023) 116678, <https://doi.org/10.1016/j.enconman.2023.116678>.
- [88] Y.Z. Zheng Chen, Simin Wu, Shiquan Shen, Yonggang Liu, Fengxiang Guo, Co-optimization of velocity planning and energy management for autonomous plug-in hybrid electric vehicles in urban driving scenarios, *Energy* vol. 263 (2023) 126060, <https://doi.org/10.1016/j.energy.2022.126060>.
- [89] T.P. Lillicrap et al., Continuous control with deep reinforcement learning," *4th International Conference on Learning Representations, ICLR 2016 - Conference Track Proceedings*, 2016.
- [90] Y. Wu, H. Tan, J. Peng, H. Zhang, H. He, Deep reinforcement learning of energy management with continuous control strategy and traffic information for a series-parallel plug-in hybrid electric bus, *Appl. Energy* vol. 247 (2019) 454–466, <https://doi.org/10.1016/j.apenergy.2019.04.021>.
- [91] Z. Ma, Q. Huo, T. Zhang, J. Hao, W. Wang, Deep deterministic policy gradient based energy management strategy for hybrid electric tracked vehicle with online updating mechanism, *IEEE Access* vol. 9 (2021) 7280–7292, <https://doi.org/10.1109/ACCESS.2020.3048966>.
- [92] R. Lian, J. Peng, Y. Wu, H. Tan, H. Zhang, Rule-interposing deep reinforcement learning based energy management strategy for power-split hybrid electric vehicle, *Energy* vol. 197 (2020) 117297, <https://doi.org/10.1016/j.energy.2020.117297>.
- [93] R. Finesso, E. Spessa, M. Venditti, "An Unsupervised Machine-Learning Technique for the Definition of a Rule-Based Control Strategy in a Complex HEV," *SAE International Journal of Alternative Powertrains*, vol. 5, no. 2, pp. 2016–01-1243, Apr. 2016, doi: 10.4271/2016-01-1243.
- [94] X. Lin, K. Li, L. Wang, A driving-style-oriented adaptive control strategy based PSO-fuzzy expert algorithm for a plug-in hybrid electric vehicle, *Expert Syst. Appl.* vol. 201 (2022) 117236, <https://doi.org/10.1016/j.eswa.2022.117236>.
- [95] C. Chang, W. Zhao, C. Wang, Y. Song, A novel energy management strategy integrating deep reinforcement learning and rule based on condition identification, *IEEE Trans. Veh. Technol.* vol. 72 (2) (2023) 1674–1688, <https://doi.org/10.1109/TVT.2022.3209817>.
- [96] Y. Xing, C. Lv, D. Cao, C. Lu, Energy oriented driving behavior analysis and personalized prediction of vehicle states with joint time series modeling, *Appl. Energy* vol. 261 (2020) 114471, <https://doi.org/10.1016/j.apenergy.2019.114471>.
- [97] J. Hou, D. Yao, F. Wu, J. Shen, X. Chao, Online vehicle velocity prediction using an adaptive radial basis function neural network, *IEEE Trans. Veh. Technol.* vol. 70 (4) (2021) 3113–3122, <https://doi.org/10.1109/TVT.2021.3063483>.
- [98] Z. Lei, D. Qin, P. Zhao, J. Li, Y. Liu, Z. Chen, A real-time blended energy management strategy of plug-in hybrid electric vehicles considering driving conditions, *J. Clean. Prod.* vol. 252 (2020) 119735, <https://doi.org/10.1016/j.jclepro.2019.119735>.
- [99] Y. Liu, J. Liu, D. Qin, G. Li, Z. Chen, Y. Zhang, Online energy management strategy of fuel cell hybrid electric vehicles based on rule learning, *J. Clean. Prod.* vol. 260 (2020) 121017, <https://doi.org/10.1016/j.jclepro.2020.121017>.
- [100] Y. Wang, et al., Genetic algorithm-based fuzzy optimization of energy management strategy for fuel cell vehicles considering driving cycles recognition, *Energy* vol. 263 (2023) 126112, <https://doi.org/10.1016/j.energy.2022.126112>.
- [101] C. Yang, R. Chen, W. Wang, Y. Li, X. Shen, C. Xiang, Cyber-physical optimization-based fuzzy control strategy for plug-in hybrid electric buses using iterative modified particle swarm optimization, *IEEE Trans. Intell. Veh.* (2023) 1–13, <https://doi.org/10.1109/TIV.2023.3260007>.
- [102] P.A. Gbadega, Y. Sun, A hybrid constrained particle swarm optimization-model predictive control (CPSO-MPC) algorithm for storage energy management optimization problem in micro-grid, *Energy Rep.* vol. 8 (2022) 692–708, <https://doi.org/10.1016/j.egy.2022.10.035>.
- [103] Y. Li, M. Chen, X. Lu, W. Zhao, Research on optimized GA-SVM vehicle speed prediction model based on driver-vehicle-road-traffic system, *Sci. China Technol. Sci.* vol. 61 (5) (2018) 782–790, <https://doi.org/10.1007/s11431-017-9213-0>.

- [104] C. Wang, R. Liu, A. Tang, Energy management strategy of hybrid energy storage system for electric vehicles based on genetic algorithm optimization and temperature effect, *J. Energy Storage* vol. 51 (2022) 104314, <https://doi.org/10.1016/j.est.2022.104314>.
- [105] H. Liu, NSGA-II optimized multiobjective predictive energy management for fuel cell/battery/supercapacitor hybrid construction vehicles, p. ArticleID:21046, *Int J. Electrochem Sci.* (2021), <https://doi.org/10.20964/2021.04.24>.
- [106] J. Tao, R. Zhang, Z. Qiao, L. Ma, Q-Learning-based fuzzy energy management for fuel cell/supercapacitor HEV, *Trans. Inst. Meas. Control* vol. 44 (10,) (2022) 1939–1949, <https://doi.org/10.1177/01423312211069488>.
- [107] H.-B. Yuan, W.-J. Zou, S. Jung, Y.-B. Kim, Optimized rule-based energy management for a polymer electrolyte membrane fuel cell/battery hybrid power system using a genetic algorithm, *Int J. Hydrog. Energy* vol. 47 (12) (2022) 7932–7948, <https://doi.org/10.1016/j.ijhydene.2021.12.121>.
- [108] J. Feng, Z. Han, Z. Wu, M. Li, A dynamic ECMS method considering vehicle speed pattern and minimum engine operation time for a range-extender electric vehicle (Jan. 2022), *IEEE Trans. Veh. Technol.* vol. 71 (5) (2022) 4788–4800, <https://doi.org/10.1109/TVT.2022.3148268>.
- [109] U.B. Tayab, J. Lu, F. Yang, T.S. AlGarni, M. Kashif, Energy management system for microgrids using weighted salp swarm algorithm and hybrid forecasting approach, *Renew. Energy* vol. 180 (2021) 467–481, <https://doi.org/10.1016/j.renene.2021.08.070>.
- [110] A. Mehbodniya et al., Hybrid Optimization Approach for Energy Control in Electric Vehicle Controller for Regulation of Three-Phase Induction Motors, *Math Probl Eng*, vol. 2022, pp. 1–13, Feb. 2022, doi: 10.1155/2022/6096983.